



Finishes

Fabrics, Vinyl, Laminates & Powder Coating



Gebesa Fabrics Collections



Gebesa Fabrics Quality

Quality is verified at our suppliers' facilities, upon receipt of materials at our facilities, and throughout production.

All Gebesa fabrics are tested to ensure their durability under real-use conditions.

Whenever possible, our testing procedures adhere to the methods established by the American Society for Testing and Materials (ASTM).

At Gebesa, we are committed to meeting and exceeding all industry standards related to our products.

We also consider aspects such as surface texture, pattern, light absorption or reflection, product conformity, and behavior within the environment when placed alongside woods, laminates, glass, carpets, surfaces, or other textiles.

Icons

The Association for Contract Textiles (ACT) has developed five icons that ensure contract fabrics meet industry standards and pass all relevant tests. These icons are included on all applicable Gebesa textile swatch cards:



Flammability: Fabric's ability to resist burning.



Wet & Dry Crocking: Fabric's colorfastness and ability to retain color in various conditions.



Colorfastness to Light: Fabric's resistance to fading when exposed to light.



Physical Properties: Fabric's resistance to pilling, seam slippage, and tearing.



Abrasion – High Traffic: Fabric's ability to withstand surface wear from rubbing.



Fabrics Testing Procedures



Flammability: The measurement of a fabric's performance when it is exposed to specific sources of ignition.

California Technical Bulletin 117-2013 Section 1 – Pass¹: These test methods consist of several tests used to evaluate the cigarette ignition resistance of upholstery cover fabrics, barrier (interliner) materials, resilient filling materials, and decking materials used in the manufacture of upholstered furniture. Each test involves a miniature assembly consisting of the component to be tested along with other specified materials, mounted on a plywood mock-up that resembles a small chair seat and back. The assembly is exposed to a lighted cigarette as an ignition source.



Abrasion*: The surface wear of a fabric caused by friction.

ASTM D4157³: The testing scope includes cutting test samples from the warp and rubbing the weft back and forth. While holding the samples in a stationary position, an ACT-approved cotton duck cloth is also rubbed backward and forward against the samples.

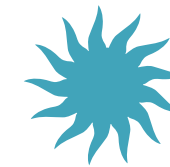

Colorfastness to Light: A material's degree of resistance to the fading effect of light.

AATCC 16 Option 1 or 3²: This test method provides the general principles and procedures for determining the colorfastness to light of textile materials. The test options described are applicable to textile materials of all kinds and for colorants, finishes and treatments applied to textile materials.

Test options included are:

- 1--Xenon-Arc Lamp, Alternate Light and Dark
- 2--Xenon-Arc Lamp, Continuous Light, Black Standard Option
- 3--Xenon-Arc Lamp, Continuous Light, Black Panel Option



Physical Properties: Key factors in assessing overall durability of a fabric vary depending on the fabric construction.

ASTM D4970: Pilling — The formation of fuzzy balls of fiber on the surface of a fabric that remain attached to the fabric.
ASTM D5034: Breaking Strength — The measurement of stress exerted to pull a fabric apart under tension.
ASTM D4034: Seam Slippage — Seam Slippage is the movement of yarns in a fabric that occurs when it is pulled apart at a seam.



Wet & Dry Crocking: Transfer of dye from the surface of a dyed or printed fabric onto another surface by rubbing.

For more details about testing procedures and quality control standards, please reach out to your Gebesa Customer Service Executive.

***Note:**

Abrasion test results exceeding ACT Performance Guidelines are not an indicator of product lifespan. Multiple factors affect fabric durability and appearance retention.

References:

- ¹State of California. Department of Consumer Affairs.
- ²American Association of Textile Chemists and Colorists, RTP, NC, USA.
- ³NextGen Material Testing, Inc.

Finishes Care And Maintenance

General Recommendations

To preserve the quality of your Gebesa textiles, please follow the cleaning procedures outlined below. The care and maintenance instructions for Gebesa products are provided as a service for your convenience.

Avoid having your furniture exposed directly to sunlight for a long time as this can cause discoloration.

Place a board on the surface when using cutters or any other sharp object, as it can scratch the paint.

Some detergent ingredients can be very aggressive and could damage painted surfaces. Avoid cleaners that contain any of the following ingredients:

- Hydrochloric acid
- Muriatic acid
- Hydrogen chloride
- Sulfuric acid
- Oleic acid
- Vitroil oleum oil
- Hydrofluoric acid
- Rust remover
- Phosphoric acid
- Sodium hydroxide
- Caustic soda

Vinyl

For regular cleaning, remove dirt and stains with a mixture of mild soap and warm water, apply only the foam with a soft cloth or a soft bristle brush.

Remove debris from the foam with a clean, dry cloth before it dries.

Repeat this procedure to remove dirt or stains on the vinyl.

Ink stains may eventually be removed by cleaning the vinyl surface with soap and water, and then applying isopropyl alcohol.

Over time, your vinyl furniture will develop a character all its own, adding to its distinctive charm.

Vinyl matures gracefully, with each piece acquiring its own patina—a rich, natural sheen—as it ages.

Fabrics

For regular cleaning, gently brush or vacuum the surface to prevent dust accumulation. For spills or stains:

- Clean immediately.
- Remove as much of the staining agent as possible from the surface.
- Gently brush and absorb excess liquid.
- Drying completely will make cleaning more difficult.

Recommendations

- DO NOT use vacuum cleaner rotary accessories or brushes as they can permanently damage the texture of the textile or change its characteristics.
- DO NOT apply water or excess liquid solutions on the textile, as it may cause permanent damage.

The instructions for the care and maintenance of Gebesa products are provided as a guide.

No warranty is implied since results may vary.

Some cleaning products may affect the cushioning material, so it is recommended to test on a non-visible area first

Guidelines

Fabrics that are patterned, textured, or have sheen can have a distinctly different appearance if applied in different directions on chairs or panels. Because of these differences, as well as width limits to how some fabrics can be applied to Gebesa products*, it is important to understand fabric applications.

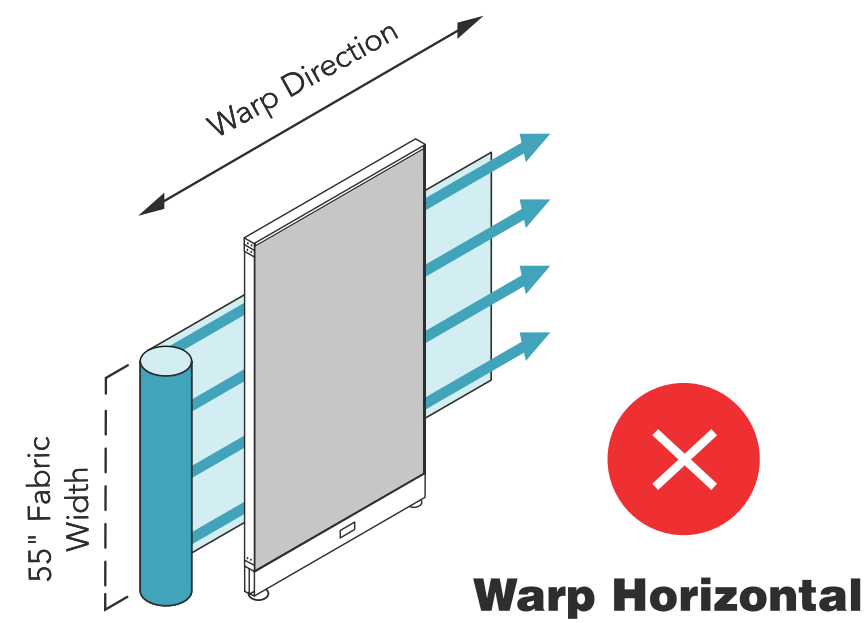

Fabrics cannot be applied warp vertical on panels with a width greater than 48 inches because panel width is greater than fabric width.

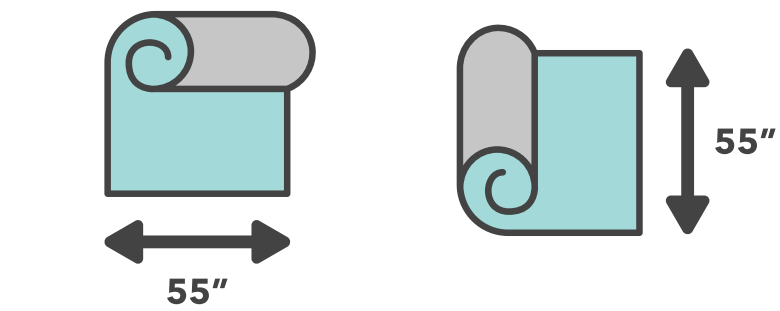

Fabrics cannot be applied warp horizontal/railroaded on panels with a height greater than 48 inches because panel height is greater than fabric width.

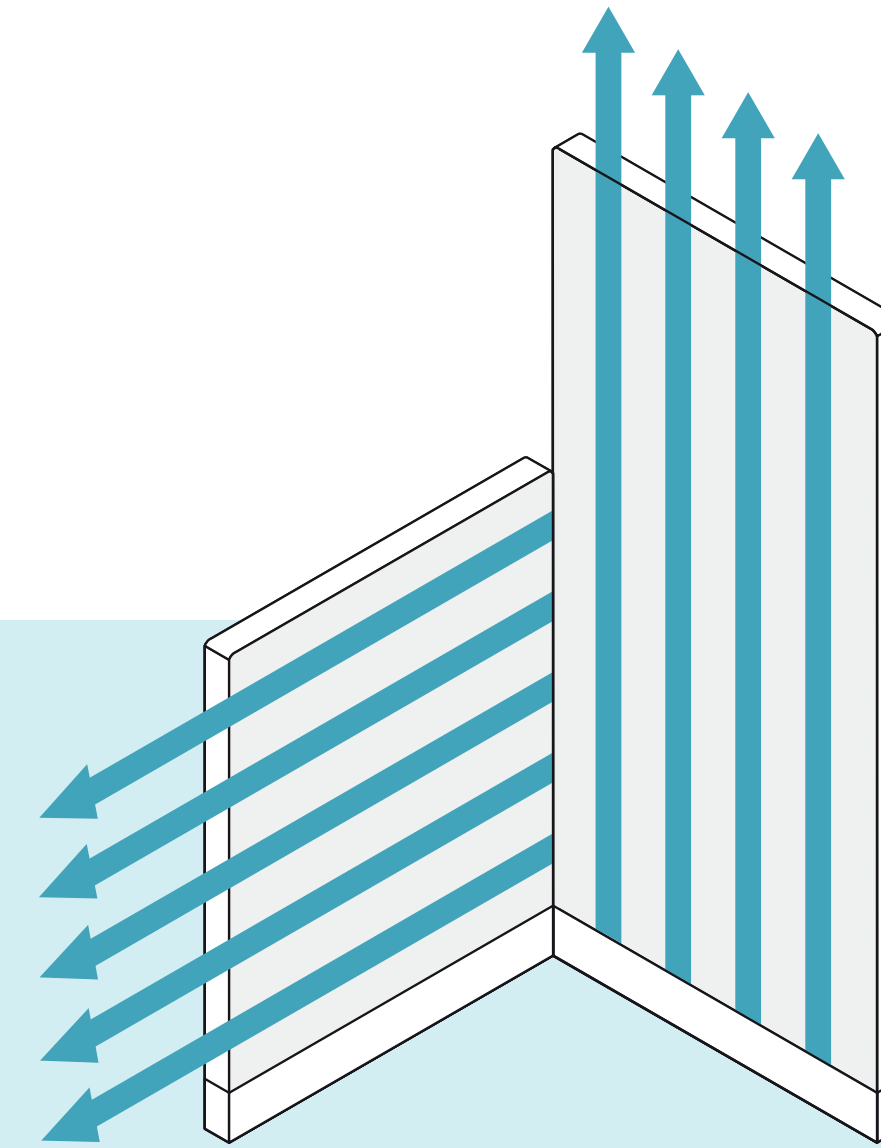
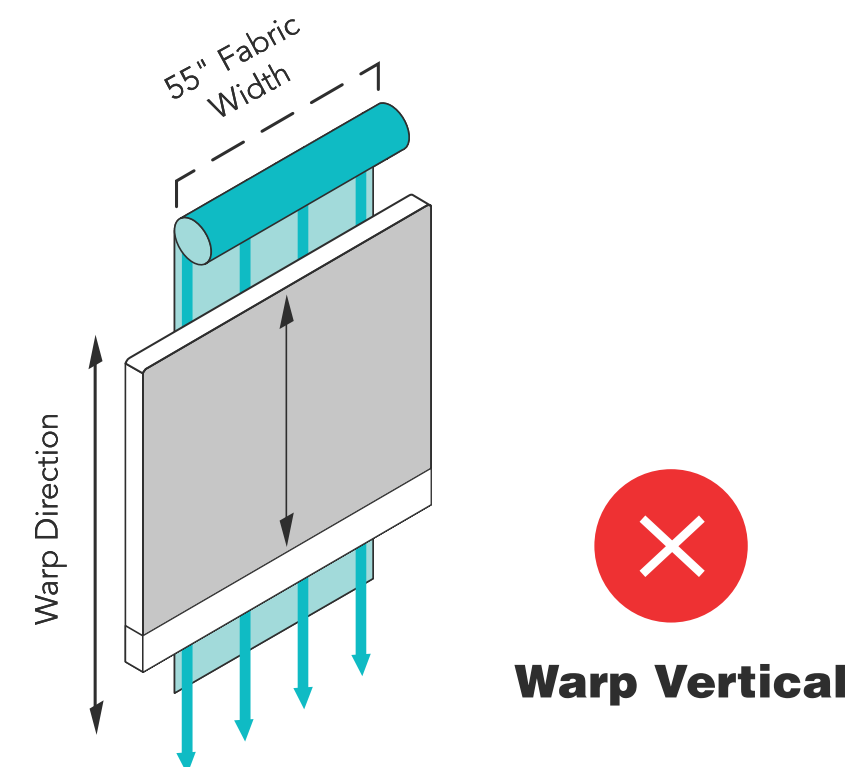

The combination of tall panels (height of 55 inches or more with warp vertical/off the roll) with short panels (height of 45 inches or less with warp horizontal) results in fabric patterns running in opposite directions.

The following options are available:

- Use solid or non-directional fabrics. (Various Gebesa fabrics are noted as “non-directional.”)
- Specify warp vertical/off the roll application for fabrics that are standard warp horizontal.

If you require warp vertical and it is not standard for your fabric choice, you must specify the warp vertical option on each line of the order.

Gebesa is not responsible for charges associated with replacement or reupholstering of products due to incorrect fabric specifications.

Technical Information

Fabric Collections	Chicago	Caribe	Crepe	Reyna	Tecno, Archie, Stella, Wonder	Ontario, Bondy, Stanley	Adisson	Sydney
Grade	A	B	B	B	B	C	E	F
Brand	Tedesa	Tedesa	Tedesa	Tedesa	Tedesa	Tedesa	Tedesa	Elastron
Content	100% Olefin fiber	100% Polyester	100% Polyolefin fiber	100% Polyester	100% Polyester	100% Polyester	100% Polyolefin fiber	100 % Polyester face & backing
Width	55.1"	55.1"	55.1"	55.1"	55.1"	55.1"	55.1"	57.1"
Weight	0.91 oz/ft	1.22 oz/ft	1.07 oz/ft	0.91 oz/ft	0.91 oz/ft	0.91 oz/ft	1.07 oz/ft	0.94 oz/ft
Abrasion	No double rubs 90,000 cycles	No double rubs 30,000 cycles	No double rubs 90,000 cycles	No double rubs 30,000 cycles	No double rubs 30,000 cycles	No double rubs 30,000 cycles	No double rubs 90,000 cycles	> 50,000 Martindale cycles (EN ISO 12947-12)
Lightfastness	Grade 4-5, 20hrs.	Grade 3-4, 20hrs.	Grade 4-5, 20hrs.	Grade 3-4, 20hrs.	Grade 4-5, 20hrs.	Grade 3-4, 20hrs.	Grade 4-5, 20hrs.	Grade 5 (EN ISO 105-B02)
Flammability	Self extinguishing, melting point 275°F	Self extinguishing, melting point 275°F	Self extinguishing, melting point 275°F	Self extinguishing, melting point 275°F	Self extinguishing, melting point 275°F	Self extinguishing, melting point 275°F	Self extinguishing, melting point 275°F	Pass – BS 5852 Pt 1 • EN 1021-1 • CA TB 117-2013 • NFPA 260 (Cigarette Test)

Technical Information

Vinyl Colors	Black, Beige, Gray, Coffee, Ivory	Denali Sand, Avanti Chocolate, Denali E. Saddle, Denali Saddle Brown, Royal Blue	Wallaby Off White, Red	Aqua	Maglia	Linetex
Grade	A	B	B	B	S	S
Brand	Maclin	Maclin	Maclin	Maclin	Spradling	Spradling
Content	100% virgin PVC resin base	100% virgin PVC resin base	100% virgin PVC resin base	100% virgin PVC resin base	Vinyl / Urethane composite (Permablock™ finish)	100 % PVC (Permablock / Permacool Plus™ finish)
Width	54"	54"	54"	54"	54"	54"
Weight	2.01 oz/ft	2.01 oz/ft	2.04 oz/ft	1.89 oz/ft	2.23 oz/ft	2.18 oz/ft
Abrasion	15,000 cycles Taber CFFA-1 b	15,000 cycles Taber CFFA-1 b	15,000 cycles Taber CFFA-1 b	15,000 cycles Taber CFFA-1 b	> 100,000 Martindale cycles (UNE-EN ISO 12947-2)	> 100,000 Martindale cycles (UNE-EN ISO 12947-2)
Lightfastness	300 hours ASTM G-154	300 hours ASTM G-154	—	1000 hours ASTM G-154	ISO 105-B02 Blue Wool 7 · 1 000 h ISO 105-B04 ≥ Grey Scale 4 (1 000 h)	ISO 105-B02 Blue Wool 7 · 1 000 h ISO 105-B04 ≥ Grey Scale 4 (1 000 h)
Flammability	CTB 117 cover fabric test	CTB 117 cover fabric test	CTB 117 cover fabric test	CTB 117 cover fabric test	Pass: CAL TB 117, NFPA 260, EN 1021-1/2, FMVSS 302, DIN 4102 B2	Pass: CAL TB 117, NFPA 260, EN 1021-1/2, FMVSS 302, DIN 4102 B2

Textiles Application Chart

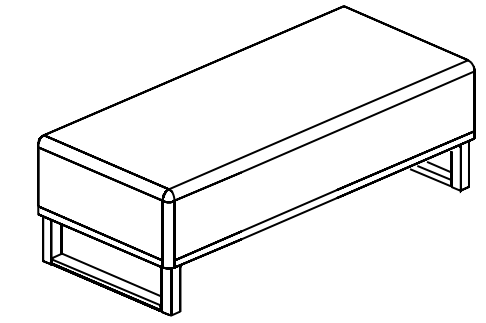
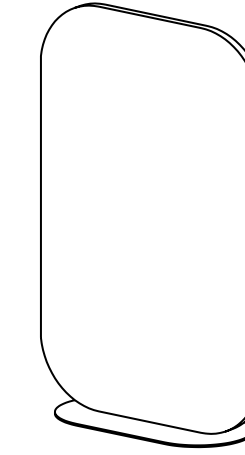
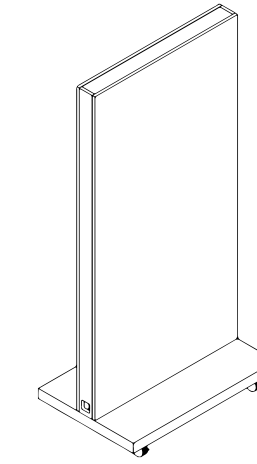
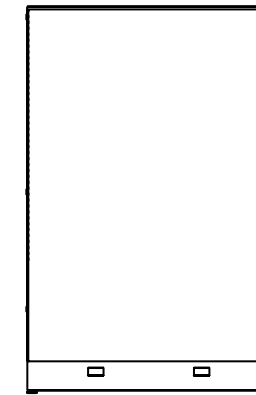
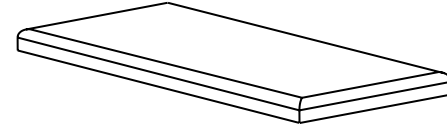
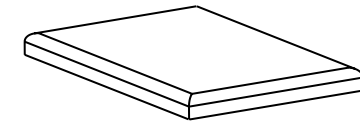
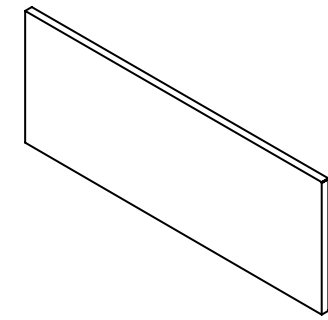

	Tackable Screens	Pedestal / Lateral File Cushions	G-Connect Credenza Cushions	Modular Systems Panels	Venti Mobile Hub Panels	Zone Space Dividers	Venti Sofas Upholstery
Grade A Fabrics	● (5% upcharge)	● (5% upcharge)	● (5% upcharge)	●	●	● (5% upcharge)	● (5% upcharge)
Grade B Fabrics	●	●	●	●	●	● (5% upcharge)	● (5% upcharge)
Grade C Fabrics	●	●	●	●	●	● (5% upcharge)	● (5% upcharge)
Grade E Fabrics	●	●	●	●	●	●	●
Grade F Fabrics	●	●	●	●	●	● Review price list	●

- Standard Products: Price as shown in the Price List.
- Semi-Special Products: List price + percentage shown in the table.
- Not available.

Textiles Application Chart

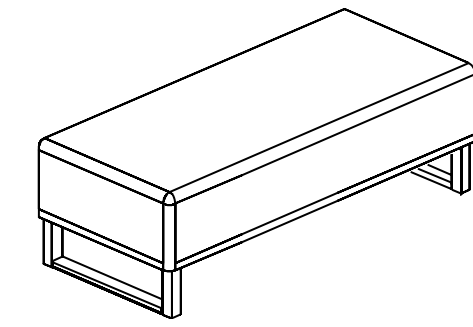
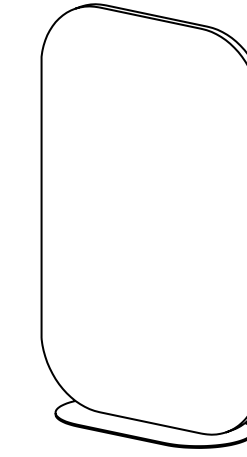
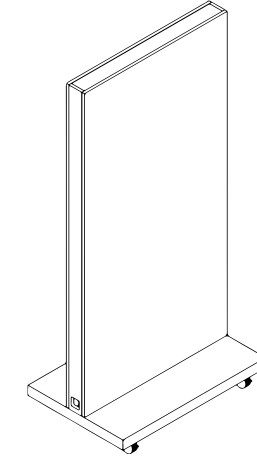
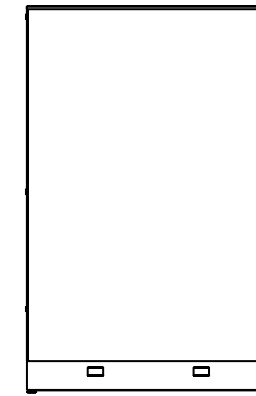
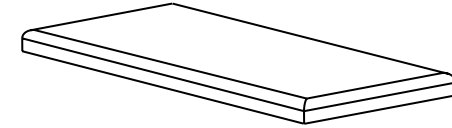
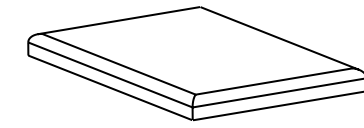
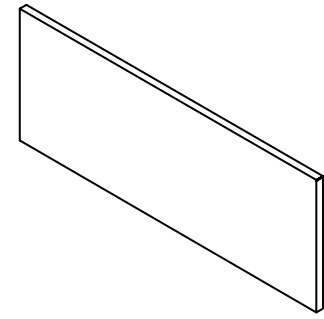
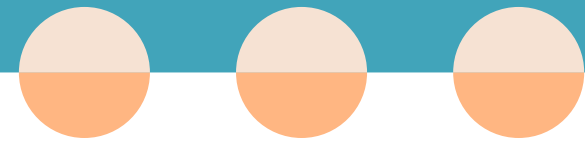

Tackable Screens

Pedestal / Lateral File Cushions

G-Connect Credenza Cushions

Modular Systems Panels

Venti Mobile Hub Panels

Zone Space Dividers

Venti Sofas Upholstery

Grade A Vinyl



(20% upcharge)

(20% upcharge)



(25% upcharge)

Grade B Vinyl



(25% upcharge)

(25% upcharge)



(25% upcharge)

Grade S Vinyl



Review price list

Review price list



Review price list



Review price list

- Standard Products: Price as shown in the Price List.
- Semi-Special Products: List price + percentage shown in the table.
- Not available.

Textiles Application Chart











									
	Loft Chairs	Dali Chairs ¹	Quo Black (seat only)	Quo White (seat only)	Sky Chairs (seat only)	Vera Gray (seat only)	Vera Black (seat only)	Kibo Gray (seat only)	Kibo Black (seat only)
Crep Fabrics	•	•	•	•	•	•	•	•	•
Black Fabric	•	•	•	•	•	•	•	•	•
Grade A Fabrics	•	•	•	•	• (7% upcharge)	•	•	•	•
Grade B Fabrics	•	•	•	•	• (7% upcharge)	•	•	•	•
Grade C Fabrics	•	•	•	•	• (10% upcharge)	•	•	•	•
Grade E Fabrics	•	•	•	•	• (10% upcharge)	•	•	•	•
Grade F Fabrics	•	•	•	•	• Review price list	•	•	•	•

- Standard Products: Price as shown in the Price List.
- Semi-Special Products: List price + percentage shown in the table.
- Not available.

1.- Dali chair is ONLY AVAILABLE in gray mesh or black vinyl.

Textiles Application Chart



									
	Loft Chairs	Dali Chairs ¹	Quo Black (seat only)	Quo White (seat only)	Sky Chairs (seat only)	Vera Gray (seat only)	Vera Black (seat only)	Kibo Gray (seat only)	Kibo Black (seat only)
Grade A Vinyl	●	●	●	●	● (15% upcharge)	●	●	●	●
Grade B Vinyl	● (5% upcharge)	●	●	●	● (20% upcharge)	●	●	●	●
Grade S Vinyl	● Review price list	●	●	●	● Review price list	●	●	●	●

- Standard Products: Price as shown in the Price List.
- Semi-Special Products: List price + percentage shown in the table.
- Not available.

1.- Dali chair is **ONLY AVAILABLE** in gray mesh or black vinyl.

Textiles Application Chart

						
	Indi Chairs (seat only)	Eneas Chairs ²	Arrow Chairs (seat only)	Syris Chairs (seat only)	Luma Chair	Fabrizia Chairs
Casper Fabrics	•	•	•	•	•	•
Black Fabric	•	•	•	•	•	•
Grade A Fabrics	• (7% upcharge)	•	•	•	• (10% upcharge)	•
Grade B Fabrics	• (7% upcharge)	•	•	•	• (10% upcharge)	•
Grade C Fabrics	• (10% upcharge)	•	•	•	• (10% upcharge)	•
Grade E Fabrics	• (10% upcharge)	•	•	•	•	•
Grade F Fabrics	• Review price list	•	•	•	• Review price list	•

- Standard Products: Price as shown in the Price List.
- Semi-Special Products: List price + percentage shown in the table.
- Not available.



2.- Eneas chair is **ONLY AVAILABLE** in blue fabric with chrome base or gray fabric with black base.

Textiles Application Chart

	 Indi Chairs (seat only)	 Eneas Chairs ²	 Arrow Chairs (seat only)	 Syris Chairs (seat only)	 Luma Chair	 Fabriza Chairs
Grade A Vinyl	● (15% upcharge)	●	●	●	● (20% upcharge)	●
Grade B Vinyl	● (20% upcharge)	●	●	●	● (25% upcharge)	●
Grade S Vinyl	● Review price list	●	●	●	● Review price list	●

- Standard Products: Price as shown in the Price List.
- Semi-Special Products: List price + percentage shown in the table.
- Not available.











2.- Eneas chair is **ONLY AVAILABLE** in blue fabric with chrome base or gray fabric with black base.

Textiles Application Chart

									
	Ika Chairs (seat only)	Discovery Bench	Match Sofas	Seti Chairs and Bench	Mobile Ottoman	Piero Sofas	Prisma Sofas	Comfort Sofas	Rewind (seat only)
Couture, Intuition, Jane, Terra Fabrics	●	●	●	●	●	●	●	●	●
Grade A Fabrics	● (5% upcharge)	●	● (5% upcharge)	●	● (5% upcharge)	● (5% upcharge)	● (5% upcharge)	●	●
Grade B Fabrics	● (5% upcharge)	● (5% upcharge)	● (5% upcharge)	● (10% upcharge)	● (5% upcharge)	● (5% upcharge)	● (5% upcharge)	● (10% upcharge)	●
Grade C Fabrics	● (5% upcharge)	●	● (5% upcharge)	● (10% upcharge)	● (5% upcharge)	● (5% upcharge)	● (5% upcharge)	● (10% upcharge)	●
Grade E Fabrics	● (5% upcharge)	●	● (5% upcharge)	● (10% upcharge)	●	● (5% upcharge)	● (5% upcharge)	● (10% upcharge)	●
Grade F Fabrics	● Review price list	● Review price list	● Review price list	● Review price list	● Review price list	● Review price list	● Review price list	● Review price list	●

- Standard Products: Price as shown in the Price List.
- Semi-Special Products: List price + percentage shown in the table.
- Not available.

Textiles Application Chart

									
	Ika Chairs (seat only)	Discovery Bench	Match Sofas	Seti Chairs and Bench	Mobile Ottoman	Piero Sofas	Prisma Sofas	Comfort Sofas	Rewind (seat only)
Grade A Vinyl	● (20% upcharge)	●	● (20% upcharge)	●	● (20% upcharge)	●	●	●	●
Grade B Vinyl	● (25% upcharge)	● (5% upcharge)	● (25% upcharge)	● (5% upcharge)	● (25% upcharge)	● (5% upcharge)	● (5% upcharge)	● (5% upcharge)	●
Grade S Vinyl	●	● Review price list	● Review price list	● Review price list	● Review price list	● Review price list	● Review price list	● Review price list	●

- Standard Products: Price as shown in the Price List.
- Semi-Special Products: List price + percentage shown in the table.
- Not available.

Grade A **Fabrics**

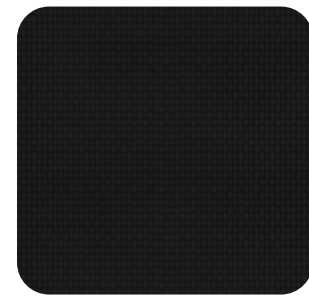

Chicago
Black
TG00



Chicago
Wine
TG48

Technical Information

Fabric Collections

Chicago

Grade

A

Brand

Tedesa

Content

100%
Olefin fiber

Width

55.1"

Weight

0.91 oz/ft

Abrasion

No double rubs 90,000
cycles

Lightfastness

Grade 4-5, 20hrs.

Flammability

Self extinguishing,
melting point 275°F

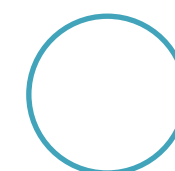
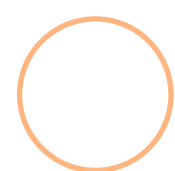

Grade B Fabrics



Technical Information			
Fabric Collections	Caribe	Crepe	Reyna
Grade	B	B	B
Brand	Tedesa	Tedesa	Tedesa
Content	100% Polyester	100% Polyolefin fiber	100% Polyester
Width	55.1"	55.1"	55.1"
Weight	1.22 oz/ft	1.07 oz/ft	0.91 oz/ft
Abrasion	No double rubs 30,000 cycles	No double rubs 90,000 cycles	No double rubs 30,000 cycles
Lightfastness	Grade 3-4, 20hrs.	Grade 4-5, 20hrs.	Grade 3-4, 20hrs.
Flammability	Self extinguishing, melting point 275°F	Self extinguishing, melting point 275°F	Self extinguishing, melting point 275°F

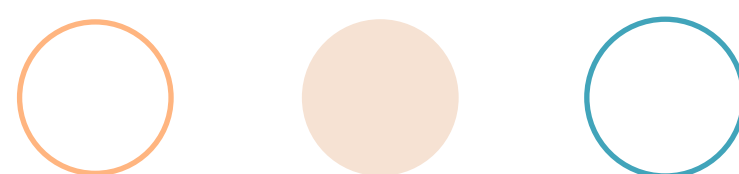

Grade B Fabrics



Technical Information		
Fabric Collections	Reyna	Tecno, Archie, Stella, Wonder
Grade	B	B
Brand	Tedesa	Tedesa
Content	100% Polyester	100% Polyester
Width	55.1"	55.1"
Weight	0.91 oz/ft	0.91 oz/ft
Abrasion	No double rubs 30,000 cycles	No double rubs 30,000 cycles
Lightfastness	Grade 3-4, 20hrs.	Grade 4-5, 20hrs.
Flammability	Self extinguishing, melting point 275°F	Self extinguishing, melting point 275°F

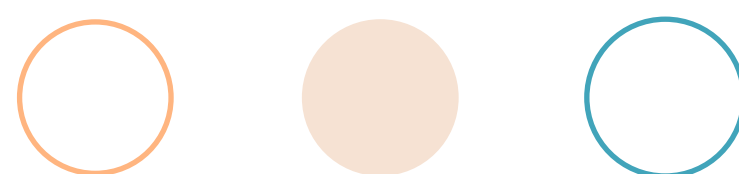

Grade C Fabrics



Technical Information

Fabric Collections	Ontario, Bondy, Stanley
Grade	C
Brand	Tedesa
Content	100% Polyester
Width	55.1"
Weight	0.91 oz/ft
Abrasion	No double rubs 30,000 cycles
Lightfastness	Grade 3-4, 20hrs.
Flammability	Self extinguishing, melting point 275°F



Grade E **Fabrics**



Technical Information

Fabric Collections	Adisson
Grade	E
Brand	Tedesa
Content	100% Polyolefin fiber
Width	55.1"
Weight	1.07 oz/ft
Abrasion	No double rubs 90,000 cycles
Lightfastness	Grade 4-5, 20hrs
Flammability	Self extinguishing, melting point 275°F



Grade F Fabrics



Technical Information

Fabric Collections	Sydney
Grade	F
Brand	Elastron
Content	100 % Polyester face & backing
Width	57.1"
Weight	0.94 oz/ft
Abrasion	> 50,000 Martindale cycles (EN ISO 12947-12)
Lightfastness	Grade 5 (EN ISO 105-B02)
Flammability	Pass BS 5852 Pt 1 • EN 1021-1 • CA TB 117-2013 NFPA 260 (Cigarette Test)

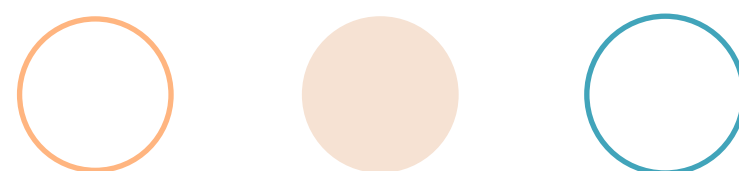

Crep Fabrics

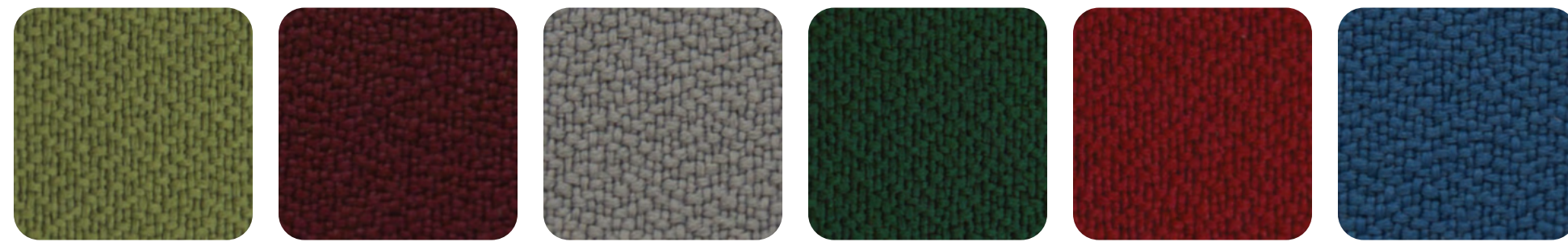

Olive Wine Pearl Green Red Blue

Casper Fabrics



Yellow Orange Blue Purple Green Gray

Specification: Casper Fabrics are restricted for use exclusively within the **Fabrizia chair**.

Technical Information

Fabric Collections	Crep, Casper
Brand	Offiho
Content	100 % Polyester
Width	55.12 in ± 3%
Weight	1.06 oz/ft
Abrasion	No double rubs 100,000 cycles
Lightfastness	Grade 5
Roll lenght	82.02-131.23ft
Celone resistance	Pass

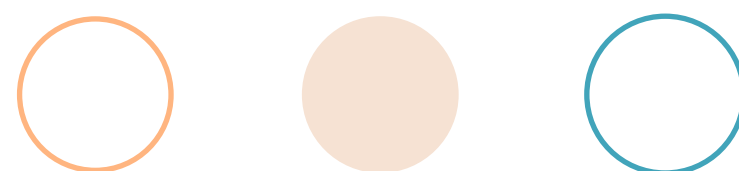

Intuition **Fabrics**



Specification: Intuition Fabrics are restricted for use exclusively within the **Rewind chair (Seat only)**.

Technical Information

Fabric Collections	Intuition
Content	100% Polyester
Brand	Requiez
Tensile strenght	210 lb
Color fastness	Dry: Class 4 Wet: Class 3
Tear strenght	65 lb
Abrasion	No double rubs 100,000 cycles
Lightfastness	Grade 4, 40hrs.
Piling resistance	Class 4

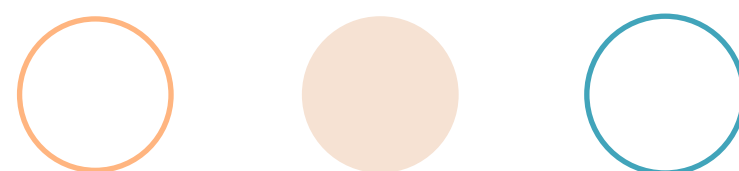

Jane Fabrics

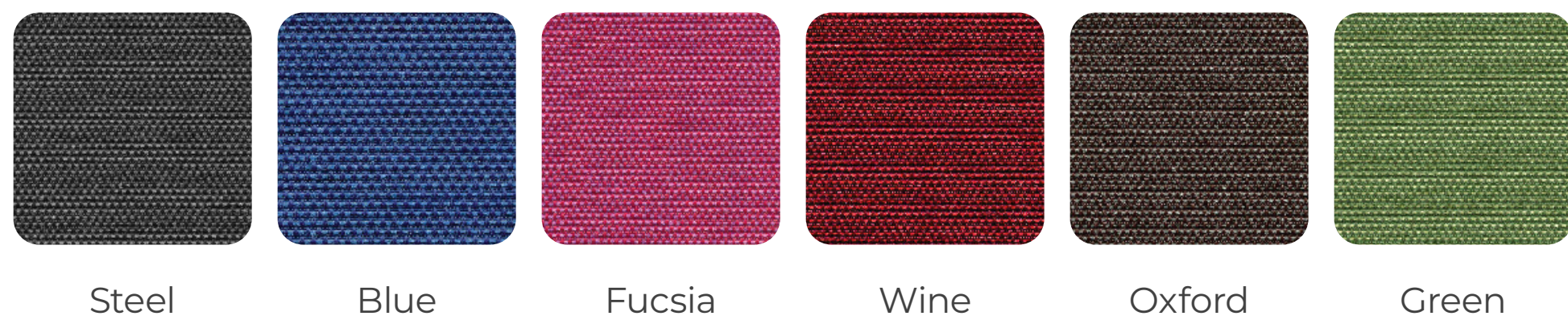

Specification: Jane Fabrics are restricted for use exclusively within the **Rewind chair**.

Terra Fabrics

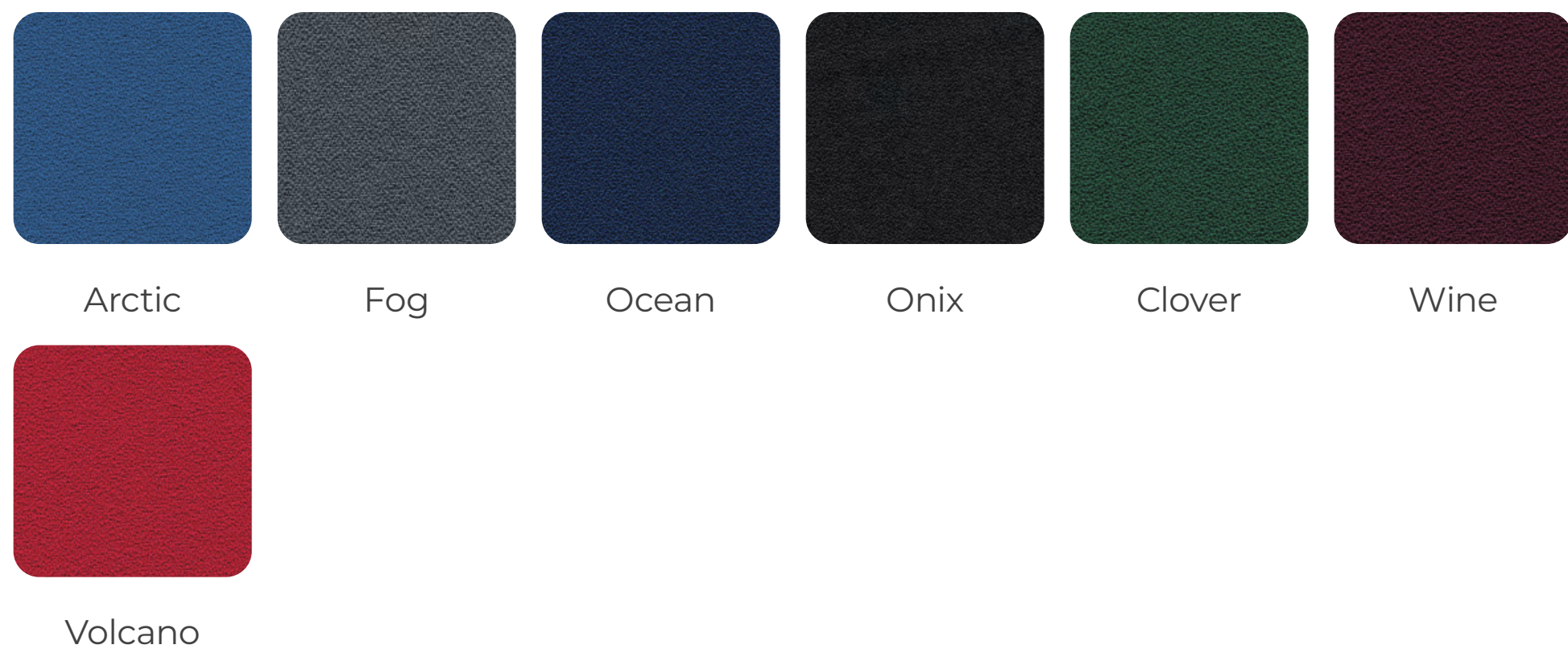

Specification: Terra Fabrics are restricted for use exclusively within the **Rewind chair**.

Technical Information

Fabric Collections	Jane	Terra
Content	100% Polyester	100% Polyester
Brand	Reqüiez	Reqüiez
Tensile strenght	200 lb	250 lb
Color fastness	Dry: Class 4 Wet: Class 3	Dry: Class 4 Wet: Class 3
Tear strenght	25 lb	20 lb
Abrasion	No double rubs 50,000 cycles	No double rubs 1,000,000 cycles
Lightfastness	Grade 4, 40hrs.	Grade 4, 40hrs.
Piling resistance	Class 4	Class 4

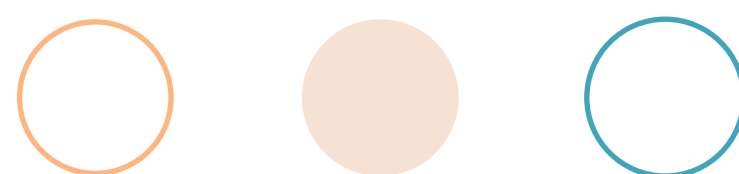

Grade A Vinyl

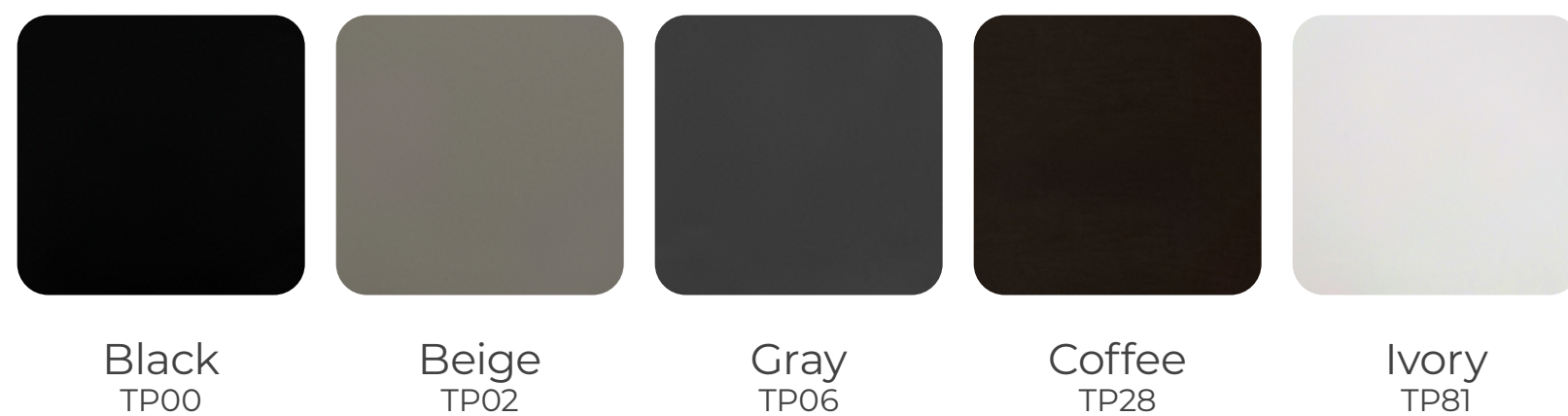

Grade B Vinyl



Technical Information				
Vinyl Colors	Black, Beige, Gray, Coffee, Ivory	Denali Sand, Avanti Chocolate, Denali E. Saddle, Denali Saddle Brown, Royal Blue	Wallaby Off White, Red, Wallaby Red	Aqua
Grade	A	B	B	B
Brand	Maclin	Maclin	Maclin	Maclin
Content	100% virgin PVC resin base	100% virgin PVC resin base	100% virgin PVC resin base	100% virgin PVC resin base
Width	54"	54"	54"	54"
Weight	2.01oz/ft	2.01oz/ft	2.04 oz/ft	1.89 oz/ft
Abrasion	15,000 cycles Taber CFFA-1 b	15,000 cycles Taber CFFA-1 b	15,000 cycles Taber CFFA-1 b	15,000 cycles Taber CFFA-1 b
Lightfastness	300 hours ASTM G-154	300 hours ASTM G-154	—	1000 hours ASTM G-154
Flammability	CTB 117 cover fabric test	CTB 117 cover fabric test	CTB 117 cover fabric test	CTB 117 cover fabric test

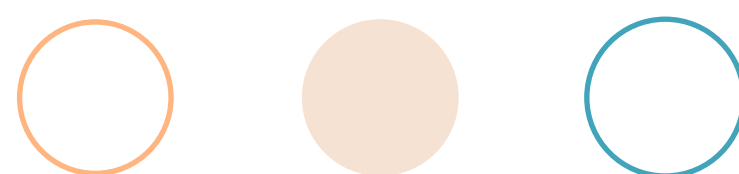

Grade S Vinyl



Maglia
Primrose
FM05

Maglia
Sage
FM09

Maglia
Ginger
FM55

Grade S Vinyl



Linetex
Chalk
FL20

Linetex
Butter
FL05

Linetex
Chestnut
FL55

Linetex
Glacier
FL06

Linetex
Shallow
FL50

Linetex
Sphere
FL67



Linetex
Iron
FL30

Linetex
Dust
FL71

Linetex
Shale
FL03

Technical Information

Vinyl Colors	Primrose, Sage, Ginger	Shale, Glacier, Butter, Chalk, Iron, Shallow, Chestnut, Dust, Sphere
Grade	S	S
Brand	Spradling	Spradling
Content	Vinyl / Urethane composite (Permablock™ finish)	100 % PVC (Permablock / Permacool Plus™ finish)
Width	54"	54"
Weight	2.23 oz/ft	2.18 oz/ft
Abrasion	> 100, 000 Martindale cycles (UNE-EN ISO 12947-2)	> 100, 000 Martindale cycles (UNE-EN ISO 12947-2)
Lightfastness	ISO 105-B02 Blue Wool 7 · 1 000 h ISO 105-B04 ≥ Grey Scale 4 (1 000 h)	ISO 105-B02 Blue Wool 7 · 1 000 h ISO 105-B04 ≥ Grey Scale 4 (1 000 h)
Flammability	Pass: CAL TB 117, NFPA 260, EN 1021-1/2, FMVSS 302, DIN 4102 B2	Pass: CAL TB 117, NFPA 260, EN 1021-1/2, FMVSS 302, DIN 4102 B2

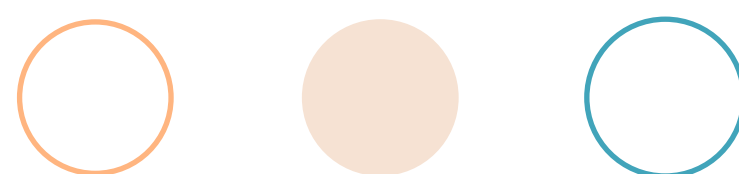

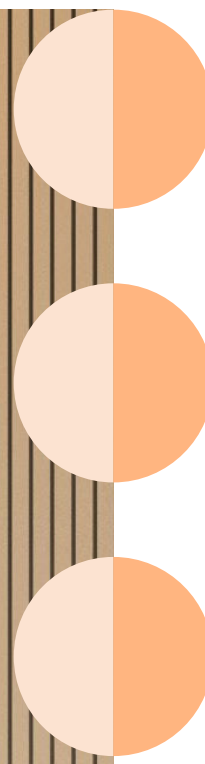

Gebesa x **interstuhl**

Partnership Fabrics

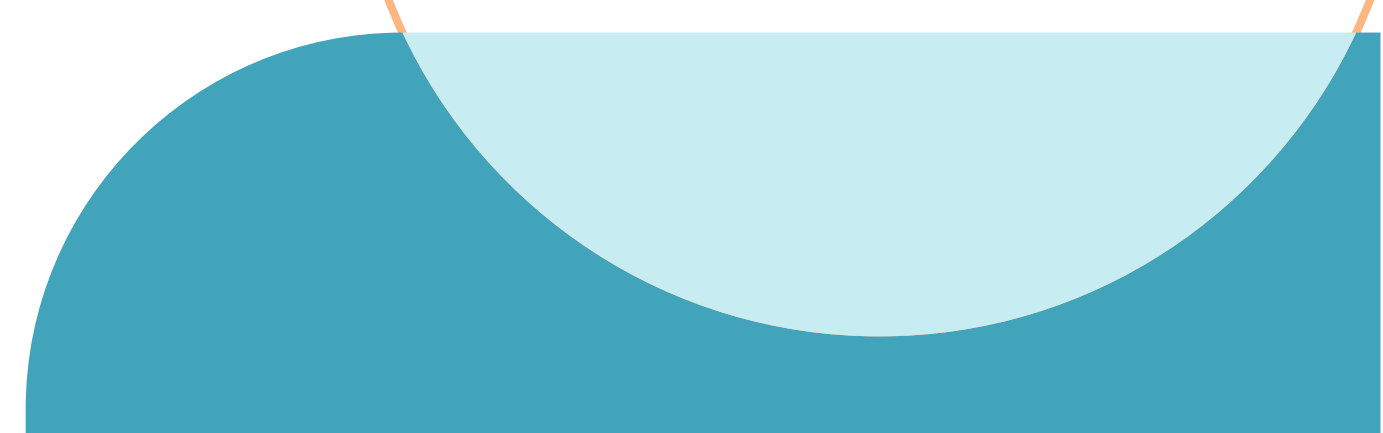

Technical Information

Fabric Collections	Era	Manhattan
Bleach cleanable	ISO 105 E03 colour change 4 for dilution factor 1:4 chlorine solution.	ISO 105 E03 colour change 4 for dilution factor 1:4 chlorine solution.
Content	100% Polyester	100% Post Consumer Recycled Polyester
Width	55.12" minimum	55.12" minimum
Weight	1.05 oz/ft ± 5%	0.95 oz/ft ± 5%
Abrasion	Heavy duty / 10 year warranty. Independently certified to ≥100,000 Martindale cycles.	Heavy duty/10 year warranty. Independently certified to ≥50,000 Martindale cycles.
Lightfastness	5 (ISO 105 - B02)	6 (ISO 105 - B02)
Fastness to Rubbing	Wet: 4, Dry: 4 (ISO 105 - X12)	Wet: 4, Dry: 4 (ISO 105 - X12)

Textiles Application Chart



Every
(seat only)

Every w/headrest
(seat and
headrest)

Every Stool
(seat only)

Buddy 4-Legs
(seat only)

Hub Sofas
(Upholstery and
accent)

Shuffle
(Inner
padding)

Shuffle Stool
(Fully
upholstered)

Shuffle
(seat only)

Era
Fabrics



Manhatan
Fabrics



- Standard Products: Price as shown in the Price List.
- Not available.

Manhattan Fabrics



Era Fabrics

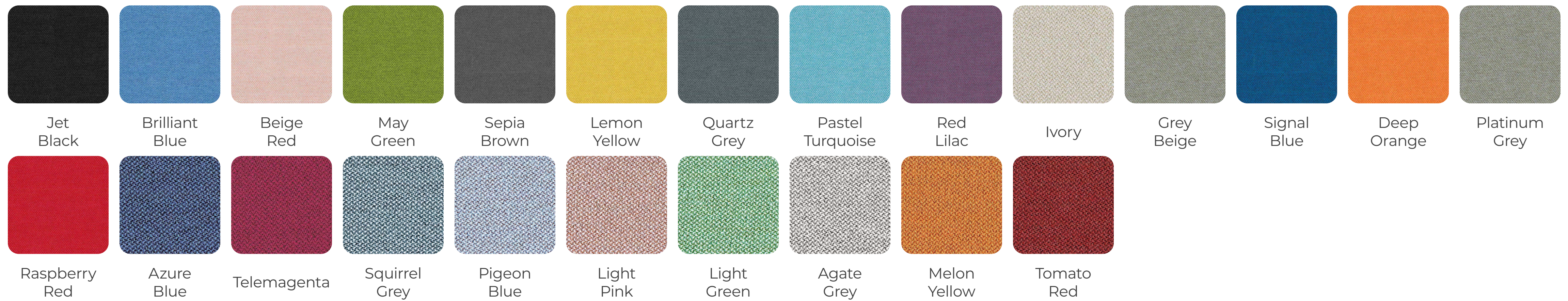

Mesh Colors

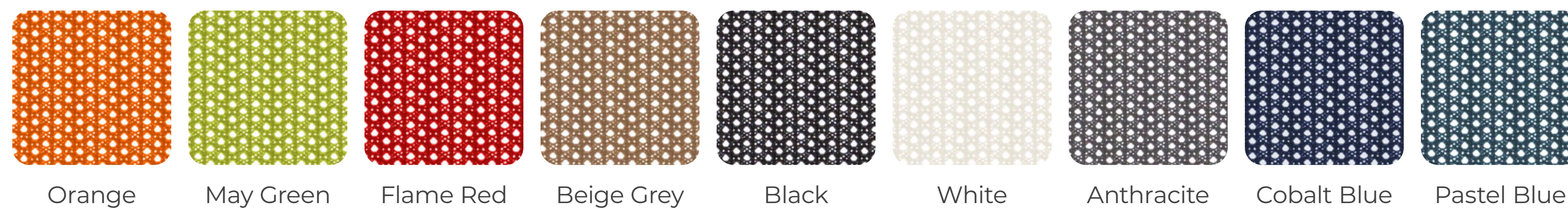

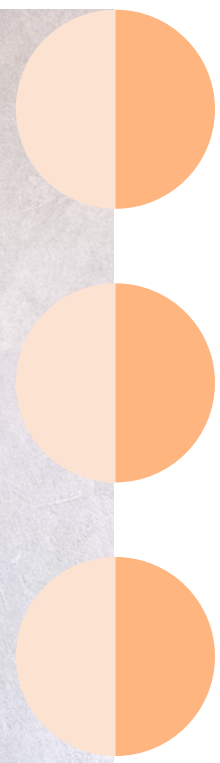

Gebesa

Laminates Collections



HPL Laminate



LPL Laminate

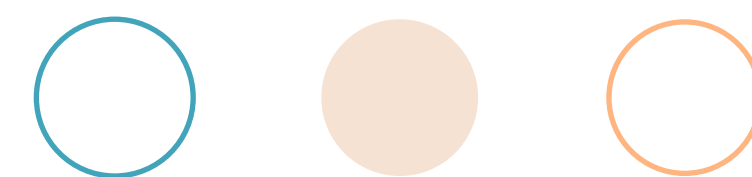
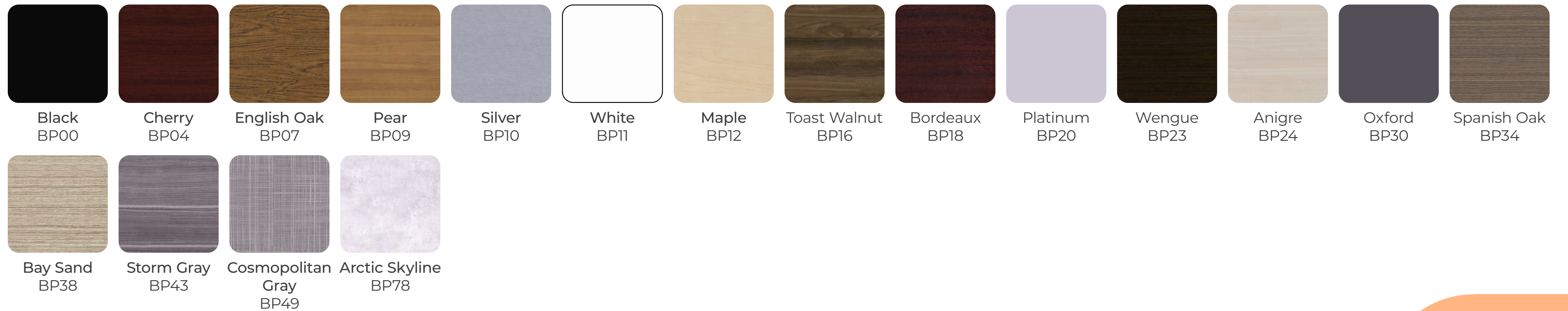

Wood Veneer **Laminates**



Walnut
CN16



Tamarind
CN17



Silver Apricot
CN19



Wengue
CN23



Cherry
CN29

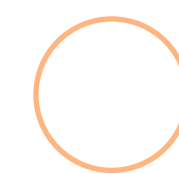
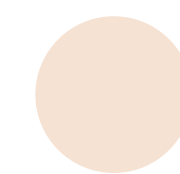
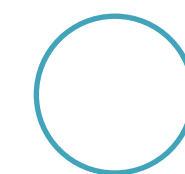

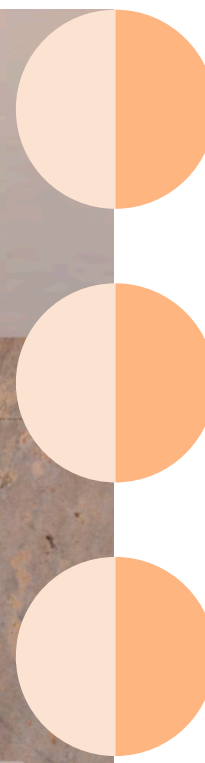

Gebesa

Powder coating Collections

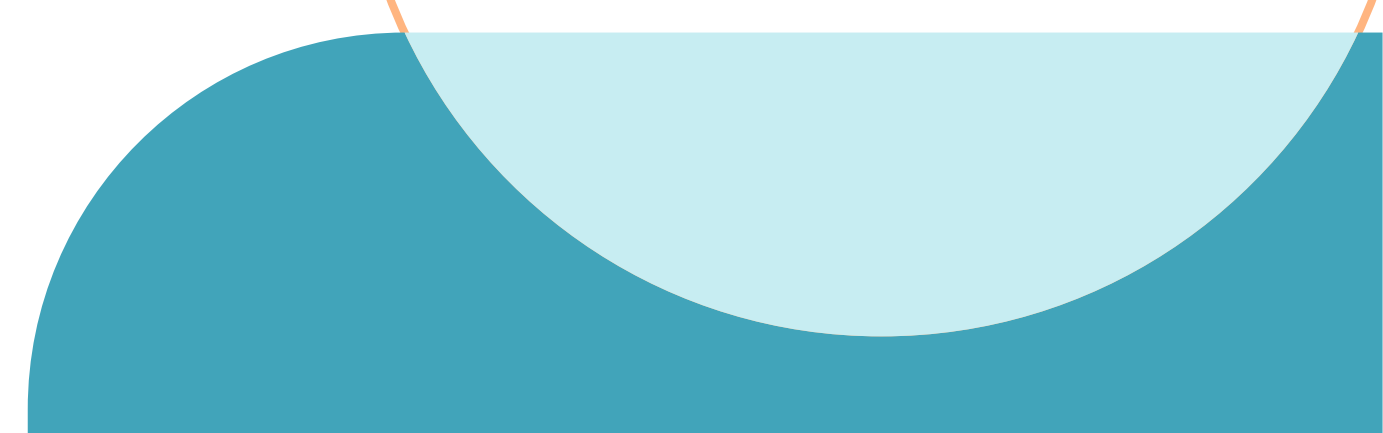

Powder Coating Application Chart



	G-Connect Structure	Ascend Structure	Urban Structure	G-Bench Structure	Start Structure	Ika Structure	Venti Sofas	Venti Collab. Tables	Venti Hub Structure	Elite Panels	Panel Systems Structure	Kenza Structure	Prime Structure	Nova Structure
Text. Black	•	•	•	•	•	•	•	•	•	•	•	•	•	•
Text. Aluminum	•	•	•	•	•	•	•	•	•	•	•	•	•	•
Oxford	•	•	•	•	•	•	•	•	•	•	•	•	•	•
Indigo Blue	•	•	•	•	•	•	•	•	•	•	•	•	•	•
Red	•	•	•	•	•	•	•	•	•	•	•	•	•	•
Orange	•	•	•	•	•	•	•	•	•	•	•	•	•	•
Green	•	•	•	•	•	•	•	•	•	•	•	•	•	•
Black	•	•	•	•	•	•	•	•	•	•	•	•	•	•
Beige	•	•	•	•	•	•	•	•	•	•	•	•	•	•
Sand	•	•	•	•	•	•	•	•	•	•	•	•	•	•
White	•	•	•	•	•	•	•	•	•	•	•	•	•	•
Platinum	•	•	•	•	•	•	•	•	•	•	•	•	•	•
R.M. Gray	•	•	•	•	•	•	•	•	•	•	•	•	•	•
Sky Blue	•	•	•	•	•	•	•	•	•	•	•	•	•	•
Highland Gray	•	•	•	•	•	•	•	•	•	•	•	•	•	•
Traffic Gray	•	•	•	•	•	•	•	•	•	•	•	•	•	•

• Semi-Special Products: List price + 5% upcharge.

Powder Coating Application Chart



G-Connect Structure Ascend Structure Urban Structure G-Bench Structure Start Structure Ika Structure Venti Sofas Venti Collab. Tables Venti Hub Structure Elite Panels Panel Systems Structure Kenza Structure Prime Structure Nova Structure

Polished Metal	●	●	●	●	●	●	●	●	●	●	●	●	●	●
Silver Steel	●	●	●	●	●	●	●	●	●	●	●	●	●	●
Ginger	●	●	●	●	●	●	●	●	●	●	●	●	●	●

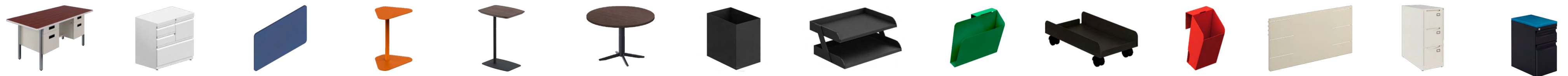

Concord Structure Global Structure MDF Screens Moss Tables Bliss Tables Structure Break Room Tables Structure Nova Metal Wastebasket Nova Metal Paper Tray Metal Hanging Shelf Nova Mobile CPU Holder Metal Pencil Holder Metallic Screens Concord Cabinets Ascend Pedestal

Text. Black	●	●	●	●	●	●	●	●	●	●	●	●	●	●
Text. Aluminum	●	●	●	●	●	●	●	●	●	●	●	●	●	●
Oxford	●	●	●	●	●	●	●	●	●	●	●	●	●	●
Indigo Blue	●	●	●	●	●	●	●	●	●	●	●	●	●	●

● Semi-Special Products: List price + 5% upcharge.

Powder Coating Application Chart

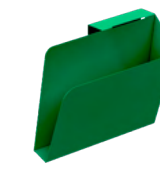

	Concord Structure	Global Structure	MDF Screens	Moss Tables	Bliss Tables Structure	Break Room Tables Structure	Nova Metal Wastebasket	Nova Metal Paper Tray	Metal Hanging Shelf	Nova Mobile CPU Holder	Metal Pencil Holder	Metallic Screens	Concord Cabinets	Ascend Pedestal
Red	•	•	•	•	•	•	•	•	•	•	•	•	•	•
Orange	•	•	•	•	•	•	•	•	•	•	•	•	•	•
Green	•	•	•	•	•	•	•	•	•	•	•	•	•	•
Black	•	•	•	•	•	•	•	•	•	•	•	•	•	•
Beige	•	•	•	•	•	•	•	•	•	•	•	•	•	•
Sand	•	•	•	•	•	•	•	•	•	•	•	•	•	•
White	•	•	•	•	•	•	•	•	•	•	•	•	•	•
Platinum	•	•	•	•	•	•	•	•	•	•	•	•	•	•
R.M. Gray	•	•	•	•	•	•	•	•	•	•	•	•	•	•
Sky Blue	•	•	•	•	•	•	•	•	•	•	•	•	•	•
Highland Gray	•	•	•	•	•	•	•	•	•	•	•	•	•	•
Traffic Gray	•	•	•	•	•	•	•	•	•	•	•	•	•	•
Polished Metal	•	•	•	•	•	•	•	•	•	•	•	•	•	•
Silver Steel	•	•	•	•	•	•	•	•	•	•	•	•	•	•
Ginger	•	•	•	•	•	•	•	•	•	•	•	•	•	•

• Semi-Special Products: List price + 5% upcharge.

Powder Coating

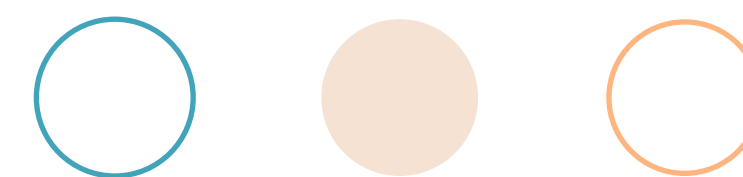
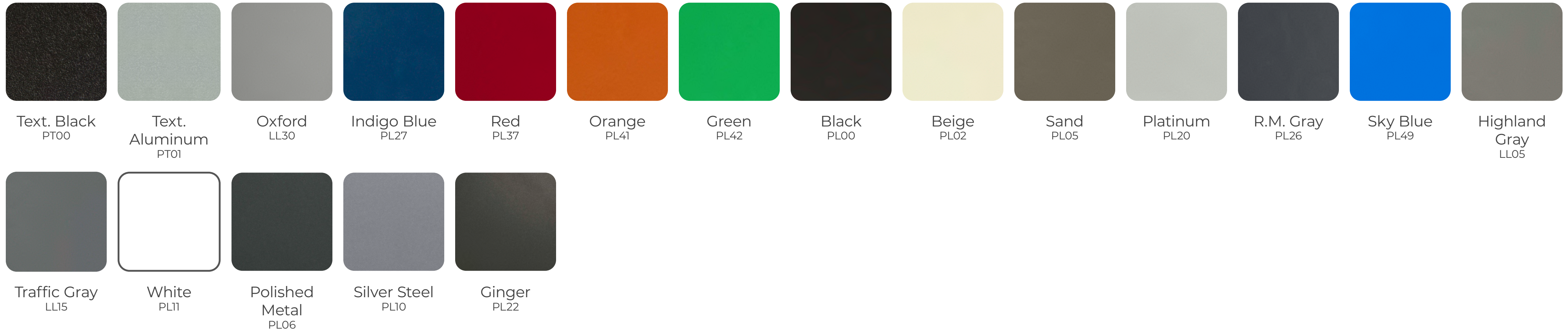

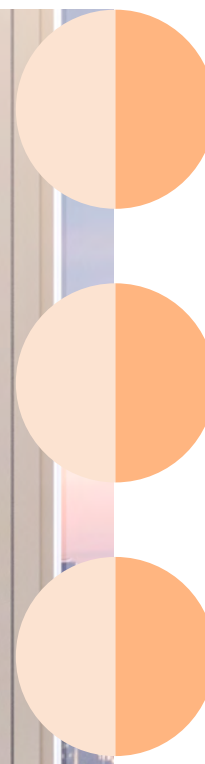

Gebesa

Premium Finishes Collections

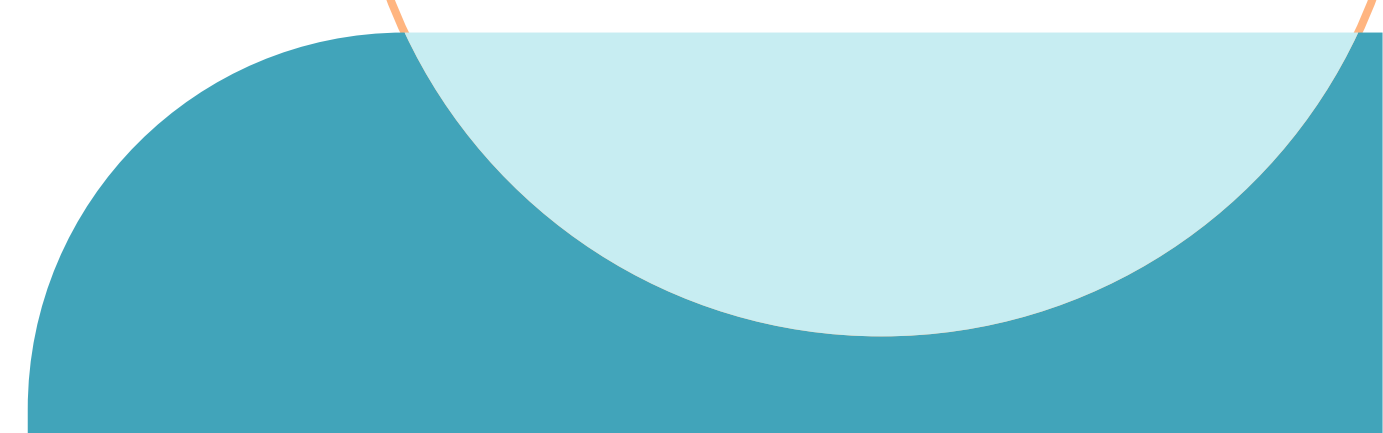
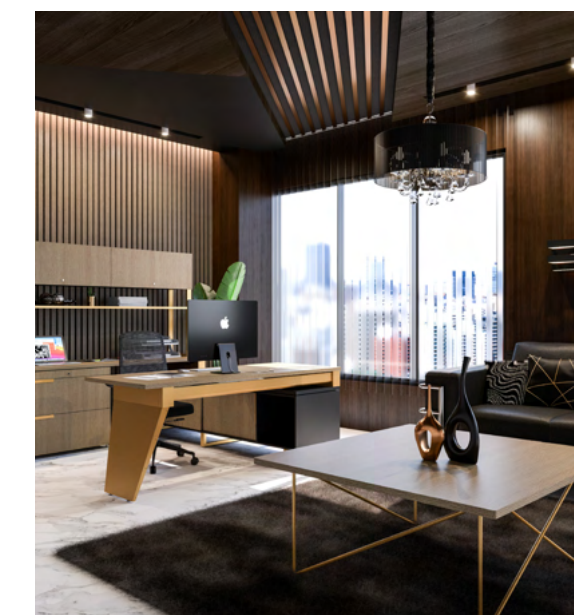

Wood Premium **Finishes**



**Mangalore
Mango**
Maple Wood
MM56

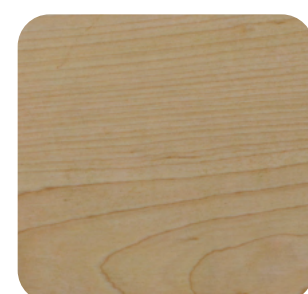

Natural
Maple Wood
MM69

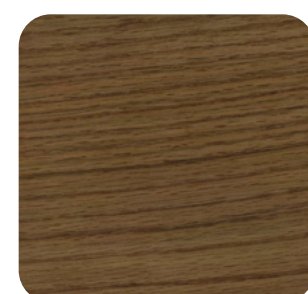

River Cherry
Red Oak Wood
MR04



Natural
Red Oak Wood
MR69



Ebony Cerused
Red Oak Wood
MR06



Natural
Birch Veneered
Plywood
MC69

Metal Premium **Finishes**



**Oil Rubbed
Bronze**
PT00



Deore
PT01



Champagne
LL30

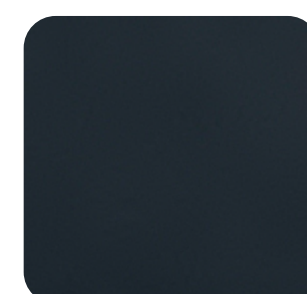

**Black Smoke
Matte**
PL27



Gun Metal
PL37

